

## Chapter 1 Safety Requirement and Cautions

To ensure safety of your health, equipment and property, please read this chapter carefully before using the solar pump inverter and act in compliance with the instructions when installing, debugging, running and overhauling the inverter.

### 1.1 Safety Definition

**Danger:** it will cause danger of serious injuries and even death while operating against the rules.

**Caution:** it will cause danger of light injuries or equipment destruction while operating against the rules.

**Note:** some information is useful while operating and using solar pump inverter.

### 1.2 Safety Requirements and Cautions

#### ●Before Installation

<b>Danger</b>
1. Only qualified personnel can operate the equipment. Before operating, be sure to carefully read the manual. The safe operation depends on the proper processes of choosing models, carrying, installation, operation and maintenance.
2. Don't use the damaged or incomplete solar pump inverters; Otherwise, there is risk of injury.

#### ●Installation

<b>Danger</b>
1. Please install the solar pump inverter on metal or other nonflammable material, and keep it away from the combustible material. Otherwise there is danger of fire.
2. No unauthorized modification to the solar pump inverter; Otherwise there is danger of damage.
3. Normal solar pump inverter without explosion-proof cannot be installed where with explosive gas or dust; Otherwise there is danger of explosion.

#### ●Wiring

<b>Danger</b>
1. Wire is connected only when the main circuit is cut off, otherwise there is a danger of shock.
2. Wire is connected by professional person only. Otherwise there is a danger of shock.
3. Earth must be reliable. Otherwise there is a danger of shock.
4. DC power supply should not be connected to output terminals U, V, W, otherwise there is a danger of damage to solar pump inverter.
5. No drop of bolt, spacer, metal stick, conducting wire or other things into the inner of solar pump inverter; Otherwise there is a danger of fire or damage to solar pump inverter.

<b>Attention</b>
1. If the damage to solar pump inverter or other equipment is caused by improper wiring and utilization or unauthorized alteration, the user should shoulder all responsibilities.

2. Please make sure all wirings meet EMC requirements and satisfy safety standards in the local area; Please refer to recommendations in this manual or national standards of wire diameter to avoid accidents.
3. Static electricity on human body would seriously damage internal MOS transistor, etc. Don't touch the printed circuit boards, IGBT or other internal devices without anti-static measurements; otherwise it will cause the malfunction to solar pump inverter.
4. Please don't connect phase shift capacitance or LC/RC noise filter to the output circuit of solar pump inverter; Otherwise it will damage the inverter.
5. Please don't connect the magnetic switch or magnetic contactor to the output circuit of solar pump inverter; When solar pump inverter is in the operation with load, magnetic switch or magnetic contactor can make inverter over-current protection act. It will damage solar pump inverter seriously.
6. Please don't dismantle the panel cover, and it only needs to dismantle the terminal cover when wiring.
7. It is forbidden to do any pressure test on solar pump inverter, otherwise it will damage the solar pump inverter.

#### ●Before Electrification

##### **Danger**

1. Please make sure that voltage grade of power supply is consistent with solar pump inverter's rated voltage and then check whether the wiring is correct, and whether there is short circuit in peripheral equipment's circuit. Otherwise it will damage solar pump inverter and other equipment.
2. Before the solar pump inverter is connected to the input power supply, make sure that the cover has been well fixed. Otherwise it will cause electric shock.
3. For the solar pump inverters whose storage time is over 1 year, when electrification, the voltage should be raised by booster from low to high. Otherwise it will damage the solar pump inverter.

##### **Attention**

1. Check if all periphery fittings are wired properly according to the handbook; Otherwise it will cause accidents.

#### ●After Electrification

##### **Danger**

1. After electrified, it is forbidden to open the cover, make wiring, and check up; Otherwise, it will cause the danger of electric shock.
2. After electrified, it is forbidden to contact internal wiring board and its parts. Otherwise it will cause the danger of electric shock.
3. Do not operate or touch solar pump inverter with wet hand. Otherwise there is danger of damage to solar pump inverter and electric shock.

**Attention**

1. Please set the parameter of solar pump inverter cautiously; Otherwise it will damage equipment.

**●Operation****Danger**

1. Before running, please check and confirm the application range of the machine and equipment once more; Otherwise it will cause accidents.
2. Please don't touch the cooling fan and braking resistance to check the temperature; Otherwise there is a danger of getting burn.
3. Unprofessional workers are banned to check the signals in the running stage; Otherwise it will cause injuries and damage the equipment.

**Attention**

1. Please don't turn off the equipment by switching off power; Please cut off the power supply after the electric machine stops running; Otherwise it will damage the solar pump inverter.
2. Please avoid anything dropping into the equipment when the solar pump inverter is running; Otherwise it will cause electric shock.

**●Maintenance****Danger**

1. Please don't maintain and repair the equipment with electric; Otherwise it will cause electric shock.
2. Before maintaining and repairing the solar pump inverter, please make sure the indicator lights of power supply have completely turned off; Otherwise it may cause electric shock and damage the solar pump inverter.
3. Persons who have not passed specialized train are not allowed to conduct the solar pump inverter maintenance; Otherwise it may cause electric shock and damage the solar pump inverter.

**1.3 Cautions in Using**

1. In application of this series solar pump inverter, you have to confirm all machine insulation to prevent damage to the equipment. Moreover, when the motor working in tough environment, please periodic inspect the electrical insulation to ensure the safety of the system work.
2. If the motor adapter is not consistent with solar pump inverter's rating current (The rating current of the motor is far smaller than that of solar pump inverter), please adjust the protective value to ensure safe running.
3. In occasions such as load raises, usually there is negative torque and solar pump inverter breaks off for over-current or over-voltage. In this case, you should consider choosing the matching brake unit.

4. Solar pump inverter, in a certain output frequency range, can meet the mechanical resonance of the load equipment. To avoid it, you can set up jumping frequency.
5. As output voltage of the inverter is pulse-wave type, if there is capacity which can improve power factor or pressure-sensitive resistance which used for thunder-proof in the voltage output side, the solar pump inverter will break off or its parts will be damaged, so it is necessary to dismantle them. Moreover, it is proposed not install switch parts like air switch and contactor (if it is necessary to install switch on output side, please make sure the output electricity of solar pump inverter is zero when the switch is working)
6. At over 1,000 meters altitude, the inverter's heat dissipation function worsened due to the thin air, it is necessary to use less.
7. The inverter output voltage is pulse wave type. If using digital multi-meter measurement, deviation of the reading will be great. And the deviation is different by using different type of digital multi-meter. Under normal circumstances, while RMS 380V, digital multi-meter reading is around 450V.
8. Solar panel can be connected in series or parallel. For rated voltage 380V controller, we suggest solar panel open circuit voltage should be between 620~ 750V.

## 1.4 Technical Specification

Solar pump inverter power(KW)	Pump		Max solar power input (KW)	Max DC input voltage (V)	Recommend Voc voltage (V)	Rated output current (A)	Output frequency (Hz)
	Rated power (KW)	Rated voltage (V)					
<b>SI30-D1 series,DC90-400V input,3 phase 110-230VAC output, MPPT voltage range 90-400VDC,for AC110V pumps</b>							
0.75	0.75	110	1.0	400	175~380	7A	0-320
1.5	1.5	110	1.95	400	175~380	10A	0-320
<b>SI30-D3 series,DC150V-450V input,3 phase 220-240VAC output, MPPT voltage range 150-450VDC, for AC220V pumps</b>							
0.75	0.75	220	1.0	450	360~430	4A	0-320
1.5	1.5	220	1.95	450	360~430	7A	0-320
2.2	2.2	220	2.86	450	360~430	10A	0-320
<b>SI30-D5 series,DC300V to 850V input,3 phase 230-460VAC output, MPPT voltage range 300-800VDC,for AC380V pumps</b>							
0.75	0.75	380	1.0	850	620~750	2.5	0-320
1.5	1.5	380	2.2	850	620~750	3.7	0-320
2.2	2.2	380	3.3	850	620~750	5.0	0-320
4	3.7	380	5	850	620~750	10	0-320
5.5	5.5	380	8	850	620~750	13	0-320
7.5	7.5	380	10	850	620~750	17	0-320
11	11	380	14.3	850	620~750	25	0-320

## 1.5 Cautions in Disposal

When you dispose solar pump inverter, please pay attention to:

1. Electrolytic capacitor: the electrolytic capacitor of main circuit or the printing plate may explode when they are burned.
2. Plastic: plastic incineration may generate toxic gases.
3. Dispose method: please dispose as industrial waste.

## Chapter 2 Installation and Wiring

### 2.1 Products Appearance

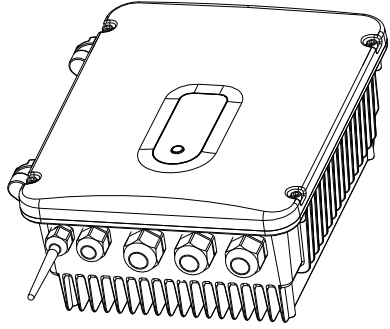
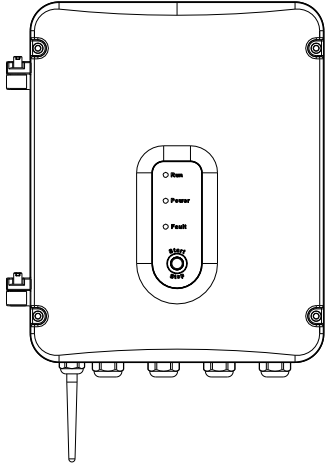

### 2.2 Open Cover

Remove 4 fixed screws in the cover and turn from right to left to open the top cover, as shown below:

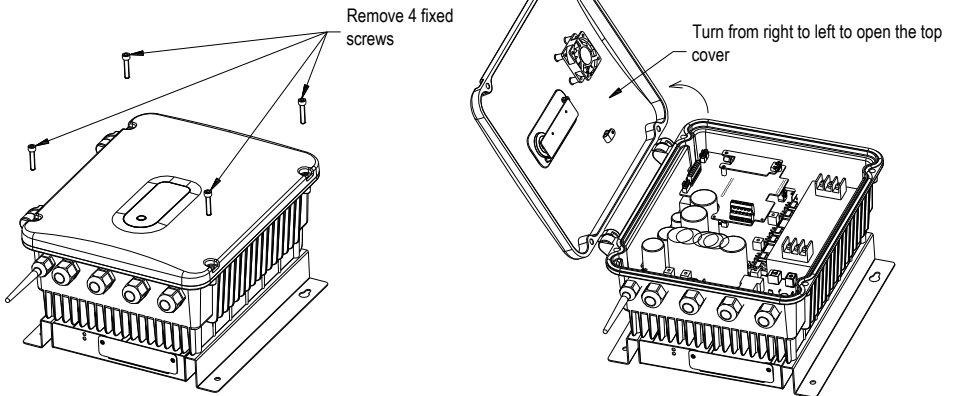

## 2.3 Inverter Dimension

Dimensions for 5.5kw and below are shown as follow:

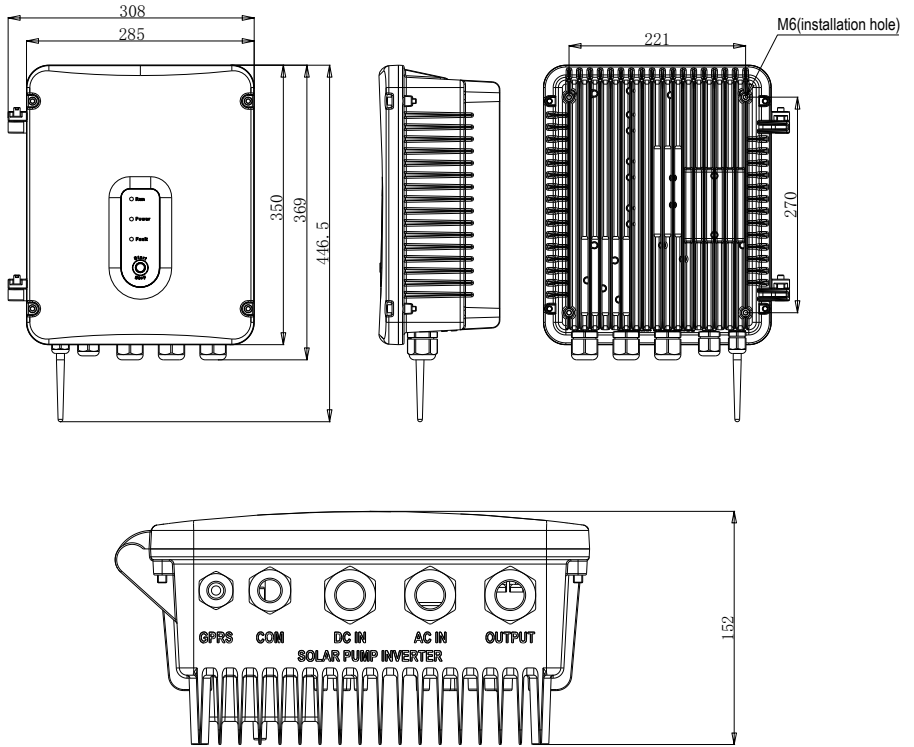

7.5kW or above dimension as follow:

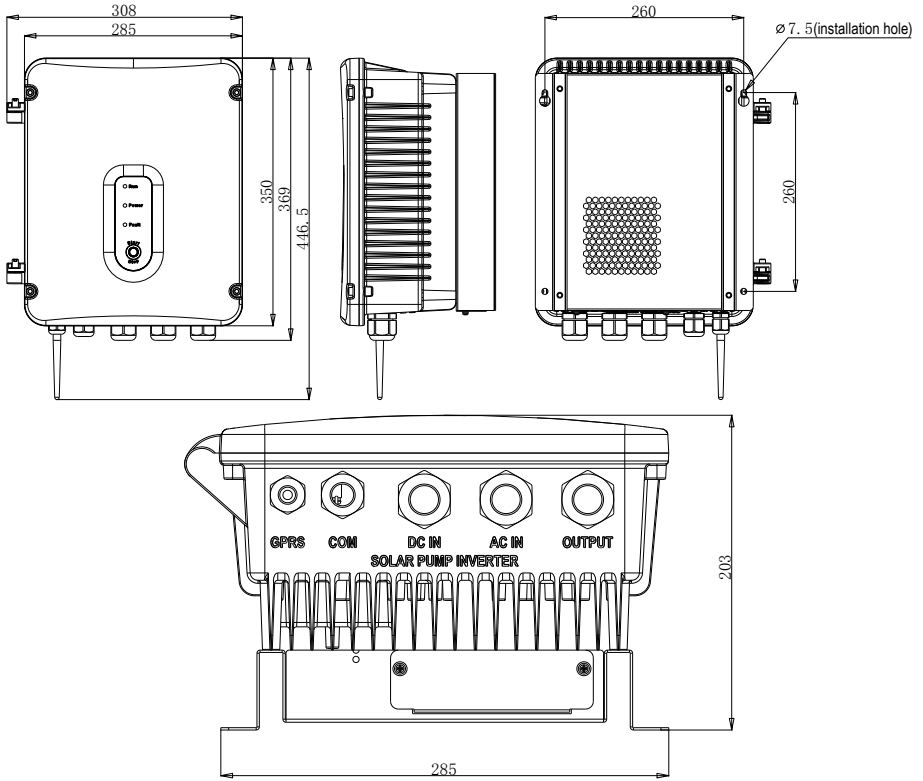

## 2.4 Solar Controller Wiring

### ● Standard Wiring

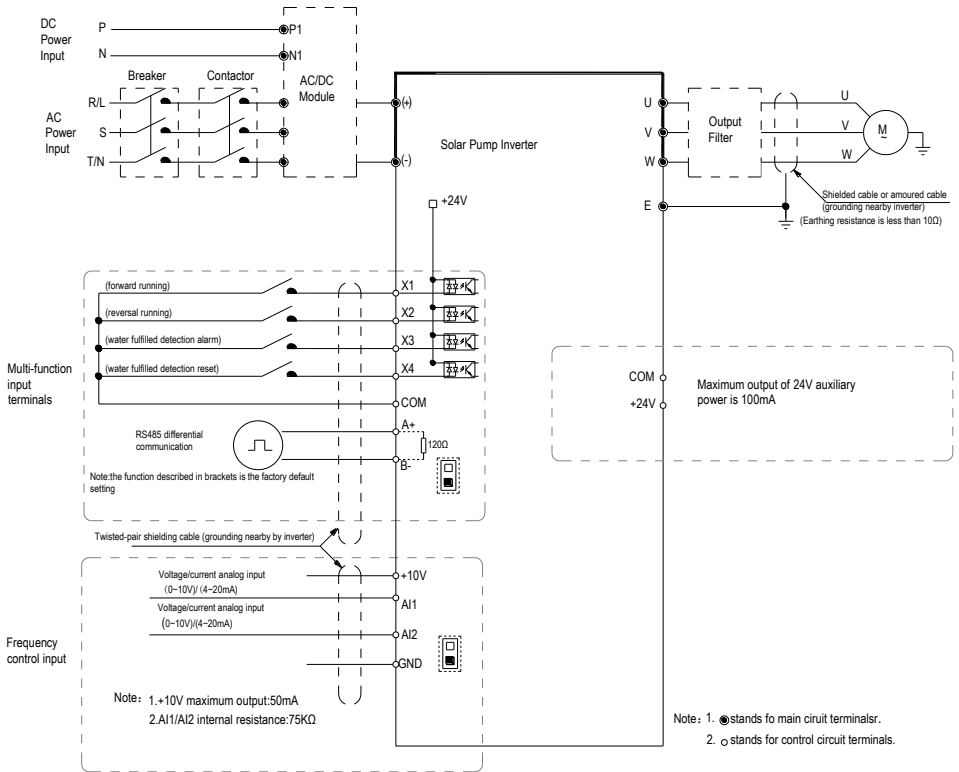

### ● Control loop terminal instructions

Terminal	Function definition	Description
+10V	10V auxiliary power supply output, constitutes loop with GND.	MAX output 50mA
+24V	24V auxiliary power supply output, constitutes loop with COM.	MAX output 100mA
COM	24V power reference ground	MAX output 24VDC/100mA
A+	RS485 communications +	
B-	RS485 communications -	
AI1	analog input 1	Voltage, current type optional
AI2	analog input 2	Voltage, current type optional
GND	analog signal ground	
X1	Forward running input, and constitutes loop with COM	
X2	Reverse running input, and constitutes loop with COM	
X3	Full water detection alarm, and constitutes loop with COM	
X4	Full water detection reset, and constitutes loop with COM	
RJ45	External keyboard connection terminal	



## 2.5 Terminal diagram

- D3 model with output filter

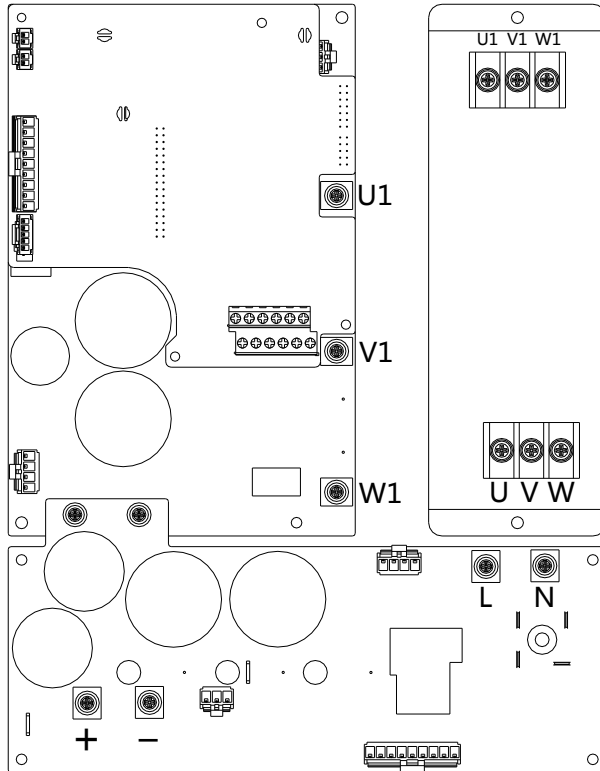

- D5 model with output filter

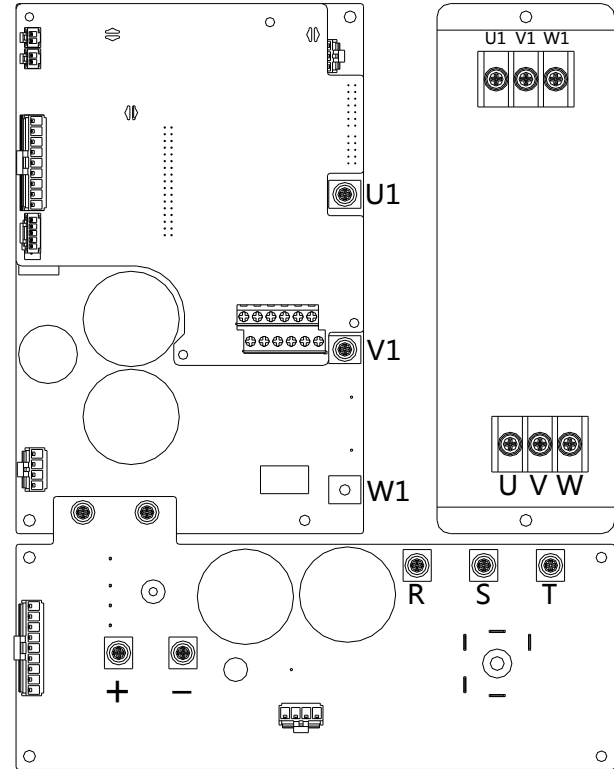

• Inverter board terminal diagram

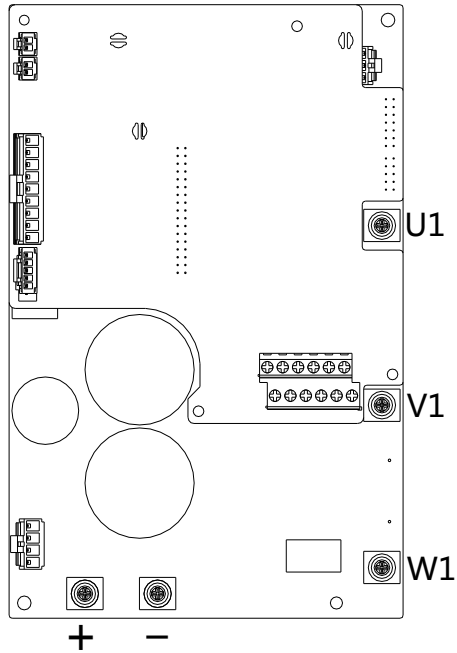

• Terminal diagram of control panel

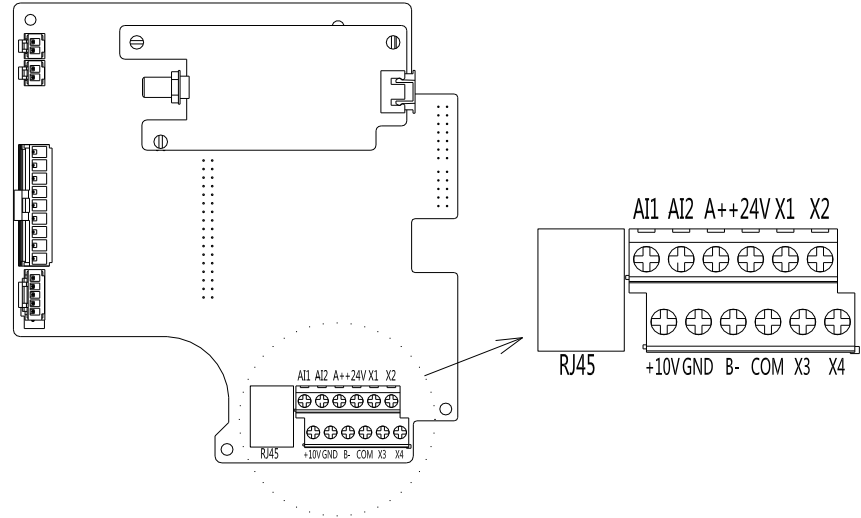





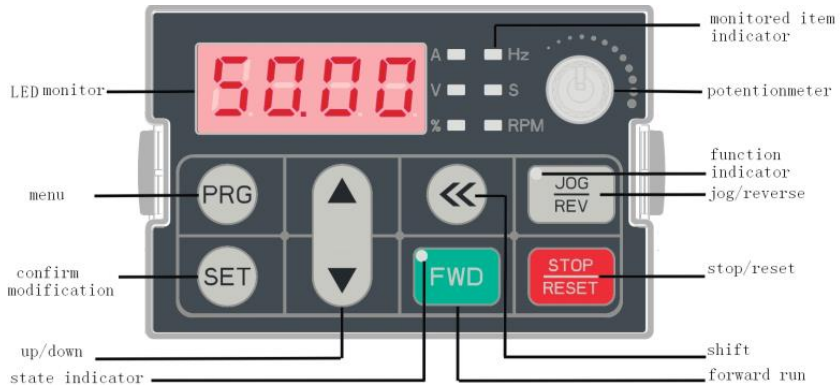

## Chapter 3 Basic Operation and Trial Run

### 3.1 Keyboard Layout and Function Specification (optional)

#### ● Keyboard Appearance



#### ● Key Function

Key	Name	Function
	Menu key	Enter menu while standby or running. Press this key to return back while modifying parameters. While standby or running, press for 1 sec to enter monitoring interface.
	Confirm/modify key	Press to modify parameter while in menu interface. Press again to confirm after modifying. While standby or running, press to change LED monitoring items at stop.
	Up/down key	Select parameter group in menu interface. Modify parameter while in modify interface. Modify given frequency, PID, given torque or magnetic powder clutch given torque while at standby or condition monitoring state.
	Shift key	Select digit of function no modified by up/down key, Select parameter digits modified by up/down key. Change LED monitoring items while standby or running.
	Forward run key	While run/stop is controlled by keyboard, press this key, the inverter forward rotate and the indicator is always on. While reverse, the indicator sparks.
	Jog/reverse key	This key function can be defined by parameter [F4.02]. Press it, machine reverses and indicator is off if this key is defined as REVERSE. Machine will jog and indicator is on if this key is defined as JOG.



● Core Control Mode Selection

Here by setting F0.00 = 0 (VC without PG) as an example to introduce,

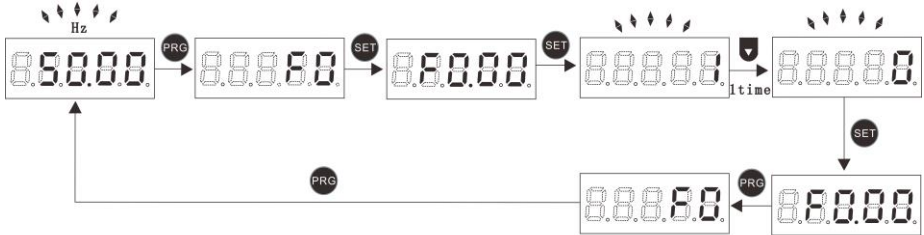

● Motor Parameter Setting

According to the motor nameplate [F5.02] (Motor rated power), [F5.03] (motor rated frequency), [F5.04] (motor rated speed), [F5.05] (motor rated Voltage). Other motor parameters can be obtained through self-learning of the inverter, the specific methods of operation are as follows:

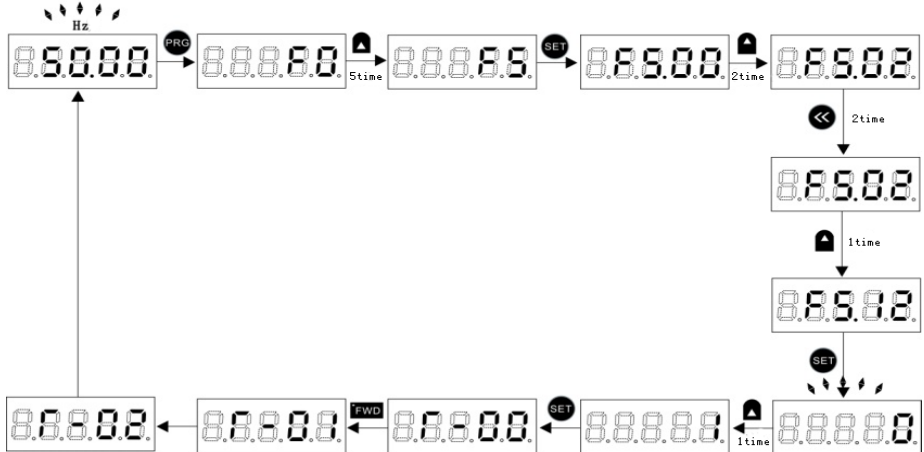

### 3.2 GPRS-D module and APP application (optional)

- GPRS-D module appearance and wiring diagram



- APP main interface and function introduction

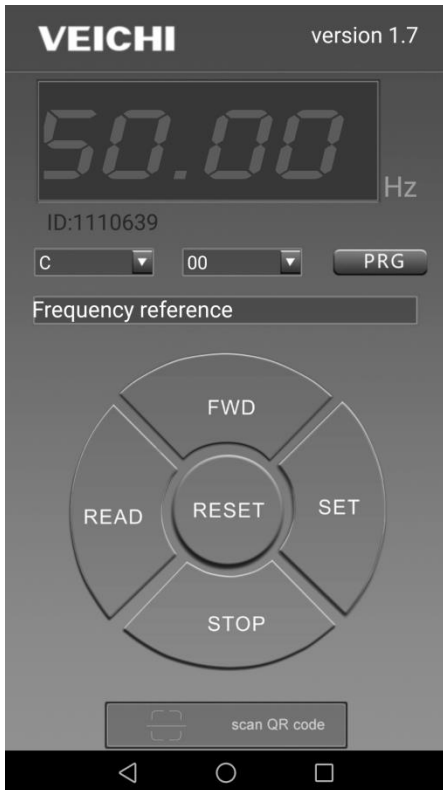

**VEICHI:** Company LOG &Chinese/ English switch

**Version:** Current APP version

**Digital tube:** current value display area

**A zone:** current numeric unit display area

**ID:** GPRS ID of current connection

**Left drop-down box:** FX parameter selection area

**Middle Dropdown box:** XX function code selection area

**PRG:** backup function, temporarily unused

**Text box:** English explain area for current code

**FWD:** Forward running key

**SET:** Numeric settings key

**STOP:** Stop key

**RESET:** Fault reset key

**READ:** Backup, temporarily unset

**Scan QR code:** Scan area of QR code

### 3.3 Panel button (standard configuration)

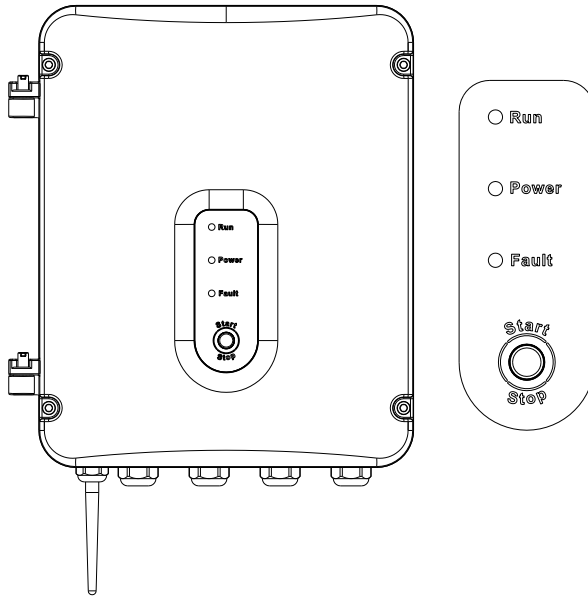

It is able to complete start /stop operation on inverter by pressing [Start/Stop] key in the cover panel only when F0.02=0. Pressing the key to start it when it is in stop status. While it is in running status, press the key to stop it. And user can also press the key to reset it when it is in fault status. The "Power" indicator will be on once power on and "Run" indicator will be on when inverter is running. As fault comes, "Fault" indicator will be always on. While "Fault" indicator is blinking, alarm comes.

## Chapter 4 Fault Diagnosis and Solution





This chapter describes the inverter fault, alerts, and operation of the failure on the inverter, the display information on inverter and countermeasures. In addition, the poor condition of the drive and motor failures will be briefly described in this chapter. Tuning guide on commissioning of the drive please refer this chapter.



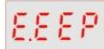

### 4.1 Fault Information and Description in Detail

Keypad display	Fault code	Fault type	Possibility reason	Troubleshooting
	E.LU2	Under voltage at runs	<ul style="list-style-type: none"> <li>● Power voltage too low</li> <li>● Power grid capacity is too low or with big current impact</li> <li>● DC main contactor don't close</li> </ul>	<ul style="list-style-type: none"> <li>● Check input power</li> <li>● Promote the power supply system</li> <li>● Seek support from factory</li> </ul>
	E.oU1	Over voltage at acceleration	<ul style="list-style-type: none"> <li>● Power voltage fluctuation over limit</li> <li>● Too start rotating motor</li> </ul>	<ul style="list-style-type: none"> <li>● Check power grid</li> <li>● Restart until motor is stop completely, or set [F1.00] set for 1 or 2</li> </ul>
	E.oU2	Over voltage during deceleration	<ul style="list-style-type: none"> <li>● Deceleration time too small</li> <li>● The driving load too heavy</li> <li>● Power voltage fluctuation over limit</li> </ul>	<ul style="list-style-type: none"> <li>● Prolong deceleration time</li> <li>● Reduce the load, or select bigger capacitor drive, or connect braking unit</li> <li>● Check input power</li> </ul>
	E.oU3	Overvoltage at constant speed	<ul style="list-style-type: none"> <li>● Voltage fluctuate above limit</li> </ul>	<ul style="list-style-type: none"> <li>● Check input voltage</li> <li>● Install input reactor</li> </ul>
	E.oU4	Over voltage at stop	<ul style="list-style-type: none"> <li>● Voltage fluctuate above limit</li> </ul>	<ul style="list-style-type: none"> <li>● Check the input voltage</li> <li>● Seek support from factory</li> </ul>
	E.oC1	Over current during acceleration	<ul style="list-style-type: none"> <li>● Acceleration time is too short</li> <li>● To start rotating motor</li> <li>● V/F setting not correct or torque boost setting too big</li> <li>● Solar drive capacitor is too small</li> </ul>	<ul style="list-style-type: none"> <li>● Prolong acceleration time</li> <li>● Restart motor when it on still, or set f1.00 for 1 or 2.</li> <li>● Reset V/f curve or torque boost setting</li> </ul>
	E.oC2	Over current during	<ul style="list-style-type: none"> <li>● The deceleration time is too short.</li> </ul>	<ul style="list-style-type: none"> <li>● Increase the deceleration time.</li> </ul>

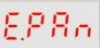
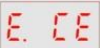

		deceleration	<ul style="list-style-type: none"> <li>● The load or inertia of load is too large</li> <li>● Solar drive capacitor is too small</li> </ul>	<ul style="list-style-type: none"> <li>● Install external braking resistor or unit</li> <li>● Select an AC drive of matching power class.</li> </ul>
E.oC3	E.oC3	Over current at constant speed	<ul style="list-style-type: none"> <li>● Load sudden change</li> <li>● The voltage of power grid is too low.</li> </ul>	<ul style="list-style-type: none"> <li>● Check the load change</li> <li>● Check the input voltage</li> </ul>
E.oL1	E.oL1	Motor overload	<ul style="list-style-type: none"> <li>● V/F curve is improper or boost torque is too big</li> <li>● The grid voltage is too lower</li> <li>● Motor overload protection coefficient is improper</li> <li>● Load is too big or motor block load</li> <li>● General motor runs at low speed for a long time</li> </ul>	<ul style="list-style-type: none"> <li>● Adjust V/F curve or boost torque</li> <li>● Check grid voltage</li> <li>● Improper setting of [F5.06/18] parameters</li> <li>● Check load condition or select matching inverter</li> <li>● Use variable frequency motor if long-term low speed running is needed.</li> </ul>
E.oL2	E.oL2	AC drive overload	<ul style="list-style-type: none"> <li>● V/F curve is improper or boost torque is too big</li> <li>● ACC. time is too short</li> <li>● Restart motor which in counter rotate</li> <li>● Load is too big</li> </ul>	<ul style="list-style-type: none"> <li>● Select an AC drive of matching power class.</li> <li>● increase the ACC./DEC. time</li> <li>● Restart motor after complete stop and set [F1.00] to 1 or 2</li> <li>● Adjust V/F curve or boost torque</li> </ul>
E.SC	E.SC	System abnormal	<ul style="list-style-type: none"> <li>● Deceleration is too short</li> <li>● Short circuit of solar drive output or phase output short circuit to ground</li> <li>● Module damage</li> <li>● EMC interface</li> </ul>	<ul style="list-style-type: none"> <li>● Prolong acceleration time</li> <li>● To check peripheral equipment</li> <li>● Ask to support</li> <li>● Check the wiring layout, cable ground</li> </ul>
E.oH1	E.oH1	Inverter over-heat	<ul style="list-style-type: none"> <li>● Temperature is too high.</li> <li>● Air channel is blocked.</li> <li>● Fan connection parts is loose.</li> <li>● Fan is damaged.</li> </ul>	<ul style="list-style-type: none"> <li>● Make the environment meet the requirement.</li> <li>● Clear the air channel.</li> <li>● Check and reconnect the wire</li> </ul>

			<ul style="list-style-type: none"> <li>●Temperature detection circuit fault.</li> </ul>	<ul style="list-style-type: none"> <li>● Change the same new fan.</li> <li>● Seek support from factory.</li> </ul>
	E.oH2	Rectifier over-heat	<ul style="list-style-type: none"> <li>●Temperature is too high.</li> <li>● Air channel is blocked.</li> <li>● Fan connection part is loose.</li> <li>● Fan is damaged.</li> <li>● Temperature detection circuit fault</li> </ul>	<ul style="list-style-type: none"> <li>●Make the environment meeting the requirement.</li> <li>● Clear the air channel.</li> <li>● Check and reconnect the wire.</li> <li>● Change the same new fan.</li> <li>● Seek support from factory.</li> </ul>
	E.TE1	Motor static detection fault	<ul style="list-style-type: none"> <li>● Detection overtime</li> <li>●Start static detection while motor is running.</li> <li>● Capacitance difference is too big between motor and inverter.</li> <li>●Motor parameter setting mistake.</li> </ul>	<ul style="list-style-type: none"> <li>● Check motor connection wire.</li> <li>● Detect after motor stopping totally.</li> <li>● Change inverter model.</li> <li>● Reset parameter according to nameplate.</li> </ul>
	E.TE2	Motor rotation detection fault	<ul style="list-style-type: none"> <li>●Detect while motor is running.</li> <li>● Detect with load.</li> <li>● Detection overtime</li> <li>●Capacitance difference is too big between motor and inverter.</li> <li>●Motor parameter setting mistake.</li> </ul>	<ul style="list-style-type: none"> <li>● Detect after motor stop totally.</li> <li>● Re-detect without load.</li> <li>● Check motor connection wire.</li> <li>● Change inverter model.</li> <li>● Reset parameter according to nameplate.</li> </ul>
	E.EEP	Memory fault	<ul style="list-style-type: none"> <li>●Electromagnetic disturb in memory period.</li> <li>● EEPROM damage.</li> </ul>	<ul style="list-style-type: none"> <li>● Resume load and save.</li> <li>● Seek support from factory.</li> </ul>
	LIFE	Reserved		
	E.ILF	Input phase loss	<ul style="list-style-type: none"> <li>●3-phase input power open phase.</li> </ul>	<ul style="list-style-type: none"> <li>●Check 3-phase power supply and the phase.</li> <li>●Check 3-phase power</li> </ul>

				supply wiring.
	E.oLF	Output phase loss	<ul style="list-style-type: none"> <li>●3-phase output power open phase</li> </ul>	<ul style="list-style-type: none"> <li>● Check 3-phase output voltage and current.</li> <li>● Check wiring.</li> </ul>
	E.Gnd	Output earth terminal short circuit.	<ul style="list-style-type: none"> <li>●Check wiring and insulation.</li> </ul>	<ul style="list-style-type: none"> <li>●Output earth</li> </ul>
	E.HAL	Current detection fault	<ul style="list-style-type: none"> <li>● Detect circuit fault.</li> <li>● Phase imbalance</li> </ul>	<ul style="list-style-type: none"> <li>●Seek support from factory</li> <li>● Check motor and wiring.</li> </ul>
	E.PAn	Keyboard connect fault	<ul style="list-style-type: none"> <li>● Keyboard wire fault.</li> <li>●Keyboard component damage.</li> </ul>	<ul style="list-style-type: none"> <li>● Check keyboard wire.</li> <li>●Seek support from factory.</li> </ul>
	Rs485 communication fault	Unsuitable baud rate setting. Communication wire breaks. Communication format does not match upper machine.	<ul style="list-style-type: none"> <li>●Set suitable baud rate setting.</li> <li>●Check communication wire.</li> <li>●Make sure right communication format.</li> </ul>	<ul style="list-style-type: none"> <li>●RS485communication fault</li> </ul>
	E.CPE	Parameter copy fault	<ul style="list-style-type: none"> <li>●Parameter copy communication is fault.</li> <li>●Copy keyboard does not match the inverter.</li> </ul>	<ul style="list-style-type: none"> <li>● Check wire.</li> <li>●Select the specified external keyboard model.</li> </ul>

## Chapter 5 Parameters List

- “●” : Stands for parameters can modify during running  
 “○” : Stands for parameters can't modify during running  
 “×” : Stands for parameter read only, can't modify  
 “-” : Stands for factory parameters, only for factory  
 “※” : Stands for relative with AC drive models

### ★ Basic Function Parameter

Function code	Function name	Setting range and definition	Default setting	property	Comm. Add
F0.00	Control mode	1 : AM linear VF control without PG 6 : Voltage vector control without PG for PMSM	1	○	0x000
F0.02	Running control mode	0 : Key board control 1 : Terminal control	0	○	0x002
F0.03	Main frequency source X reference	0 : digital reference of keyboard 1 : Potentiometer of key board 8 : PID control reference	0	○	0x003
F0.08	Digital frequency reference	0.00 ~ maximum frequency	50.00Hz	●	0x008
F0.09	Maximum frequency	0.00 ~ 320.00Hz	50.00Hz	○	0x009
F0.11	Upper limit frequency	Lower limit frequency ~ Maximum frequency	50.00Hz	●	0x00B
F0.12	Lower limit frequency	0.00~Upper limit frequency	0.00Hz	●	0x00C
F0.14	Acceleration time 1	0.01 ~ 650.00s	model set	●	0x00E
F0.15	Deceleration time 1	0.01 ~ 650.00s	model set	●	0x00F
F0.16	Rotation direction	0 : consistent 1 : Runs in reverse 2 : Forbidden reverse	0	●	0x010
F0.17	Carrier frequency	0.6 ~ 15.0kHz	model set	●	0x011
F0.19	Factory setting	0 : No operation 1 : Restore to default(motor parameters don't restore) 2 : Clear fault record 3 : Restore to default(motor parameters restore)	0	○	0x013

## ★ Running Control Parameters

Function code	Function name	Setting range and definition	Default setting	property	Comm. Add
F1.07	Stop mode	0 : Deceleration to stop 1 : Free stop	0	●	0x107
F1.13	Acceleration/deceleration mode	LED "0"digit, acceleration /deceleration time reference 0 : Maximum frequency 1 : Fixed frequency LED"00"digit : Acceleration/deceleration mode 0 : Linear 1 : S curve LED"000"digit : Reserve LED"0000"digit : Reserve	0001	○	0x10D
F1.31	Terminal running protection function	LED "0"digit : Terminal running command selection when power on 0 : invalid when power on 1 : valid when power on LED"00" digit: Terminal running command selection while running command given channel switchover 0 : Terminal running command is invalid when switching 1 : Terminal running command is valid while switching	0011	●	0x11F

## ★ Switch Terminal Parameters

Function code	Function name	Setting range and definition	Default setting	property	Comm. Add
F2.00	Multi-function terminal 1 (X1)	0 : No function    1 : Forward 2 : Reverse        6 : Free stop 7 : Emergency stop 8 : Fault reset 9 : External fault input 10 : Water full detection fault 11 : Water full detection fault Reset 22 : PID control cancel 23 : PID control pause	1	●	0x200

F2.01	Multi-function terminal 2 (X2)	See X1	2	●	0x201
F2.02	Multi-function terminal 3 (X3)	See X1	10	●	0x202
F2.03	Multi-function terminal 4 (X4)	See X1	11	●	0x203

### ★ Optional Keyboard and Display Parameters

Function code	Function name	Setting range and definition	Default setting	property	Comm. Add
F4.00	Parameters and button lock selection	0 : No lock 1 : Function parameters locked 2 : Function code and parameters lock ( except RUN/STOP/JOG) 3 : Function parameters all locked	0	●	0x400
F4.01	User password	0 ~ 9999	0	●	0x401
F4.02	Keypad REV/JOG select	0 : REV 1 : JOG	0	●	0x402
F4.05	Function copy	0 : No operation 1 : Sent parameter to keypad and store 2 : Sent stored parameters of keypad to AC drive	0	○	0x405

F4.11	The first line of keypad display in running status	LED "0"digit : First group display 0 : Frequency given 1 : Output frequency 2 : Output current 3 : Input voltage 4 : Output voltage 5 : Machine speed 6 : Reserved 7 : Output torque 8 : PID given 9 : PID feedback A : Output power B : DC bus voltage C : module temperature 1 D : module temperature 2 E : Input terminal X ON/OFF state F :Output terminal Y ON/OFF state LED"00" digit : The second group LED "000"digit : The third group LED"0000" digit : The forth group	42B1	●	0x40B
F4.12	The first line of keypad display at stop status	LED "0"digit : The first group LED "00"digit : The second group LED "000"digit : The third group LED "0000"digit digit : The forth group	42B0	●	0x40C
F4.13	The second line of keypad display in running status	LED "0"digit : The first group LED "00"digit : The second group LED "000"digit : The third group LED "0000"digit digit : The forth group	CA42	●	0x40D
F4.14	The second line of keypad display at stop status	LED "0"digit : The first group LED "00"digit : The second group LED "000"digit : The third group LED "0000"digit digit : The forth group	CA42	●	0x40E

★ Motor Parameters

Function code	Function name	Setting range and definition	Default setting	property	Comm. Add
F5.00	Motor type	0 : Asynchronous motor ( AM ) 1 :Permanent magnet motor( PM )	0	×	0x500
F5.01	Poles of motor	2 ~ 48	2	○	0x501
F5.02	Rated power of motor	0.4 ~ 1000.0kW	model set	○	0x502

F5.03	Rated frequency of motor	0.01 ~ maxi frequency	model set	<input type="radio"/>	0x503
F5.04	Rated speed of motor	0 ~ 65000rpm	model set	<input type="radio"/>	0x504
F5.05	Rated voltage of motor	0 ~ 1500V	model set	<input type="radio"/>	0x505
F5.06	rated current of motor	0.1 ~ 2000.0A	model set	<input type="radio"/>	0x506
F5.07	Motor no load current	0.01 ~ 650.0A	model set	<input type="radio"/>	0x507
F5.08	Stator resistance Of motor	0.001 ~ 65.000	model set	<input type="radio"/>	0x508
F5.09	Rotor resistance of motor	0.001 ~ 65.000	model set	<input type="radio"/>	0x509
F5.10	Stator and rotor Inductance of motor	0.1 ~ 6500.0mH	model set	<input type="radio"/>	0x50A
F5.11	Stator and rotor mutual inductance of motor	0.1 ~ 6500.0mH	model set	<input type="radio"/>	0x50B
F5.12	Motor auto tuning	0 : No operation 1 : Rotary auto tuning 2 : Stationary auto tuning	0	<input type="radio"/>	0x50C
F5.21	Stator resistance Of synchronous motor	0.001 ~ 65.000	model set	<input type="radio"/>	0x515
F5.22	Shaft D inductance of synchronous motor	0.01mH ~ 655.35mH	model set	<input type="radio"/>	0x516
F5.23	Shaft Q inductance of (synchronous motor	0.01mH ~ 655.35mH	model set	<input type="radio"/>	0x517
F5.24	Back EMF of synchronous motor of	0.1V ~ 1000.0V	model set	<input type="radio"/>	0x518
F5.25	Encoder installation angle of PM	0.0° ~ 360.0°	model set	<input type="radio"/>	0x519
F5.26	Inject frequency at high frequency	50.0Hz ~ 1000.0Hz	300.0Hz	<input type="radio"/>	0x51A
F5.27	Inject voltage at high frequency	0.1% ~ 100.0%	20.0%	<input type="radio"/>	0x51B
F5.28	Back EMF identify current	0.1% ~ 100.0%	80.0%	<input type="radio"/>	0x51C

★ Vector Control Parameters

Function code	Function name	Setting range and definition	Default setting	property	Comm. Add
F6.00	ASR(Speed loop ) proportional gain 1	0.00 ~ 1.00	0.20	●	0x600
F6.01	ASR(Speed loop) integral time 1	0.01 ~ 10.00s	0.50s	●	0x601



F6.02	ASR( speed loop) derivative time 1	0.0 ~ 100.0	0.0	●	0x602
F6.03	ASR filter time 1	0.000 ~ 0.100s	0.005s	●	0x603
F6.04	ASR switching frequency 1	0.00 ~ 50.00Hz	5.00Hz	●	0x604
F6.05	ASR(Speed loop ) proportional gain 2	0.00 ~ 1.00	0.20	●	0x605
F6.06	ASR(Speed loop) integral time 2	0.01 ~ 10.00s	0.50s	●	0x606
F6.07	ASR( speed loop) derivative time 2	0.0 ~ 100.0s	0.0s	●	0x607
F6.08	ASR filter time 2	0.000 ~ 0.100s	0.005	●	0x608
F6.09	ASR switching frequency 2	0.00 ~ 50.00Hz	10.00Hz	●	0x609
F6.45	Stabilizer proportional gain	0.1% ~ 100.0%	20.0%	●	0x62D
F6.46	Stabilizer filter time	1ms ~ 1000ms	50ms	●	0x62E
F6.47	Low-frequency current rising range	0.0% ~ 200.0%	80.0%	●	0x62F
F6.48	Low frequency current rising cut-off frequency	0.00Hz ~ 99.00Hz	50.00Hz	●	0x630
F6.49	Low frequency current rising rate	0 ~ 100.0	2.0	●	0x631
F6.50	Low frequency current control gain	0 ~ 100.0	2.0	●	0x632
F6.51	Flux strength reference	0 ~ 500%	0%	●	0x633
F6.52	Flux control proportional gain	0 ~ 9999	0	●	0x634
F6.53	Flux control integral gain	0 ~ 9999	0	●	0x635
F6.54	Overcurrent suppression point	0.0% ~ 250.0%	120.0%	●	0x636
F6.55	Overcurrent suppression gain	0% ~ 500%	100%	●	0x637
F6.56	Overcurrent suppression integral	1ms ~ 1000ms	30ms	●	0x638
F6.57	DC pull-in time	1ms ~ 9999ms	1000ms	●	0x639
F6.58	Start-up frequency	0.00Hz ~ 99.00Hz	5.00Hz	●	0x63A
F6.59	Start-up frequency time	0.0sec ~ 999.0sec	0.0sec	●	0x63B
F6.60	Low frequency rising maintain frequency	0.00Hz ~ 99.00Hz	10.00Hz	●	0x63C

## ★ Fault and Protection Parameters

Function code	Function name	Setting range and definition	Default setting	property	Comm. Add
FA.10	DC bus under voltage protection point	50.0% ~ 100.0%	70.0%	●	0xA0A

## ★ Communication Control Function Parameters

Function code	Function name	Setting range and definition	Default setting	property	Comm. Add
Fd.00	Master-slave selection(485 &CAN)	LED "0"digit : 485 communication main-slave selection : LED "00"digit : Veichi CAN main-slave selection : 0 : Slave 1 : Master	0	○	0xD00
Fd.02	Communication baud rate selection	LED "0"digit : 485 communication 0 : 1200 bps    1 : 2400 bps 2 : 4800 bps    3 : 9600 bps 4 : 19200 bps    5 : 38400 bps 6 : 57600 bps    7 : 115200 bps LED "00"digit : CAN communication 0 : 20 kbps    1 : 50 kbps 2 : 100kbps    3 : 125kbps 4 : 250kbps    5 : 500kbps 6 : 1Mbps	43	○	0xD02
Fd.10	RS485 communication protocol	0 : Modbus protocol 1 : Virtual oscilloscope protocol 2 : Reserved	0	○	0xD0A

**Note:** If you need a detailed description of parameters, please contact the manufacturer to order "AC100 Vector Inverter Manual".

## ★ Photovoltaic Pump Special Parameters

Function code	Function name	Setting range and definition	Default setting	property	Comm. Add
---------------	---------------	------------------------------	-----------------	----------	-----------

FE.00	Solar pump drive control mode	0 : Variable frequency control mode 1 : CVT mode for solar 2 : MPPT mode for solar	2	○	0xE00
FE.01	Running control mode	0 : Stop 1 : Running 2 : Sleep 3 : Low speed protection 4 : Dry run protection 5 : Over current protection 6 : Minimum power protection	Read only		0xE01
FE.02	VOC voltage	0.0 ~ 999.9V	Read only		0xE02
FE.03	CVT target voltage	70.0 ~ 95.0%	81.0%	●	0xE03
FE.04	MPPT upper limit voltage	20.0 ~ 200.0%	100.0%	●	0xE04
FE.05	MPPT lower limit voltage	20.0 ~ 200.0%	50.0%	●	0xE05
FE.06	Frequency adjusting gain	0.1 ~ 500.0%	10.0%(AM) 40.0% (PMSM)	●	0xE06
FE.07	MPPT search interval	0.1 ~ 100.0	1.0s	●	0xE07
FE.08	MPPT regulating gain	0 ~ 9999	100	●	0xE08
FE.09	Quick-drop frequency gain	0 ~ 20	2	●	0xE09
FE.10	Frequency adjusting filter time	0.001 ~ 2.000s	0.002	●	0xE0A
FE.11	Dormancy mode voltage threshold	0 ~ 1000V	0V	●	0xE0B
FE.12	Wake up restore voltage	0 ~ 1000V	400V	●	0xE0C
FE.13	Dormancy stop restore waiting time	0.0 ~ 3000.0s	10.0s	●	0xE0D
FE.14	Low speed protection detect frequency	0.00 ~ 300.00Hz	10.00Hz	●	0xE0E
FE.15	Low speed protection detect time	0.0 ~ 3000.0s	10.0s	●	0xE0F
FE.16	Low speed protection auto restore working time	0.0 ~ 3000.0s	10.0s	●	0xE10
FE.17	Dry run protection detect current	0.0 ~ 999.9A	0.0A	●	0xE11
FE.18	Dry run protection detect time	0.0 ~ 3000.0s	10.0s	●	0xE12
FE.19	Dry run auto restore working time	0.0 ~ 3000.0s	10.0s	●	0xE13

FE.20	Over current protection detect current	0.0 ~ 999.9A	0.0A	●	0xE14
FE.21	Over current protection detect time	0.0 ~ 3000.0s	10.0s	●	0xE15
FE.22	Over current protection auto restore working time	0.0 ~ 3000.0s	10.0s	●	0xE16
FE.23	minimum power protection value	0.00 ~ 650.00kw	0.00kw	●	0xE17
FE.24	Minimum power protection detect time	0.0 ~ 3000.0s	10.0s	●	0xE18
FE.25	Minimum power protection auto restore working time	0.0 ~ 3000.0s	10.0s	●	0xE19
FE.26	Fault alarm restore mode	0 : Auto reset;1 : manually reset LED0 : Low frequency protection LED1 : Dry run protection LED2 : Over current and overload protection LED3: Minimum power protection	0000	●	0xE1A
FE.27	Water fulfilled protection detect time	0.0s ~ 3000.0s	10.0s	●	0xE1B
FE.28	Water fulfilled protection exist time	0.0s ~ 3000.0s	10.0s	●	0xE1C
FE.29	reserved			●	0xE1D
FE.30	DC current revise offset	0.00 ~ 99.99A	0.0A	●	0xE1E
FE.31	DC current revise proportion gain	0.0 ~ 999.9%	100.0%	●	0xE1F
FE.32	Power curve 0	0.00 ~ 99.99kw	0.50kw	●	0xE20
FE.33	Power curve 1	0.00 ~ 99.99kw	1.00kw	●	0xE21
FE.34	Power curve 2	0.00 ~ 99.99kw	1.50kw	●	0xE22
FE.35	Power curve 3	0.00 ~ 99.99kw	2.00kw	●	0xE23
FE.36	Power curve 4	0.00 ~ 99.99kw	2.50kw	●	0xE24
FE.37	Flow curve 0	0.0 ~ 999.9m <sup>3</sup> /h	0.0 m <sup>3</sup> /h	●	0xE25
FE.38	Flow curve 1	0.0 ~ 999.9m <sup>3</sup> /h	5.0 m <sup>3</sup> /h	●	0xE26
FE.39	Flow curve 2	0.0 ~ 999.9m <sup>3</sup> /h	10.0 m <sup>3</sup> /h	●	0xE27
FE.40	Flow curve 3	0.0 ~ 999.9m <sup>3</sup> /h	15.0 m <sup>3</sup> /h	●	0xE28
FE.41	Flow curve 4	0.0 ~ 999.9m <sup>3</sup> /h	20.0 m <sup>3</sup> /h	●	0xE29
FE.42	Flow calculating revise offset	0.0 ~ 999.9m <sup>3</sup>	0.0m <sup>3</sup>	●	0xE30
FE.43	Flow calculating revise gain	0.0 ~ 999.9%	100.0%	●	0xE31
FE.44	Flow/generated power per day reset period	0.0 ~ 24.0h	7.0h	●	0xE32

FE.45	Reserved			●	0xE33
FE.46	Solar pump function selection 1	0 : Invalid 1 : Valid LED0 : Constant torque frequency limit selection LED1 : Reserved LED2 : Sudden voltage rising updates Voc voltage LED3: Fast frequency falling function	1100H	●	0xE34
FE.47	Fast frequency falling threshold	3.0% ~ 15.0%	5.0%	●	0xE35
FE.48	Constant torque frequency limit coefficient	80.0% ~ 150.0%	100.0%	●	0xE36
FE.49	Sudden voltage rising threshold	0.0% ~ 20.0%	5.0%	●	0xE37
FE.50	Fast frequency falling gain	0.1 ~ 4.0	1.0	●	0xE38
FE.51	Solar pump function selection 2	0 : Invalid 1 : Valid LED0 : AC/DC switching function LED1 :Decreasing load while over heating LED2 : Reversed LED3 : Reversed	0011H	●	0xE39
FE.52	AC/DC switching voltage point	50.0 ~ 800.0V	300V	●	0xE40

★ Photovoltaic Pump Special Monitor Parameter

Function code	Function name	Setting range and definition	Default setting	property	Comm. Add
C-00	Frequency given	0.01Hz	Read only		2100H
C-01	Output frequency	0.01Hz	Read only		2101H
C-02	Output current	0.1A	Read only		2102H
C-04	Output voltage	0.1V	Read only		2104H
C-08	Solar array voltage(DC)	0.1V	Read only		2108H
C-09	AC/DC switching status	1	Read only		2109H
C-10	Output power	0.01kw	Read only		210AH
C-11	DC bus voltage	0.1V	Read only		210BH

C-29	Output power factor	-1.00~1.00	Read only		211BH
C-30	DC current	0.01A	Read only		211EH
C-31	Flow speed	0.1 m <sup>3</sup> /h	Read only		211FH
C-32	Voc voltage	0.1 V	Read only		2120H
C-33	Flow per day	0.1 m <sup>3</sup>	Read only		2121H
C-34	Cumulative total flow(low position)	0.1m <sup>3</sup>	Read only		2122H
C-35	Cumulative total flow(high position)	0.1km <sup>3</sup>	Read only		2123H
C-36	Generated power per day	0.01kwh	Read only		2124H
C-37	Cumulative total power consumption (low position)	0.01kwh	Read only		2125H
C-38	Cumulative total power consumption (high position)	0.01Mwh	Read only		2126H

**Input terminals ON/OFF status illustration**

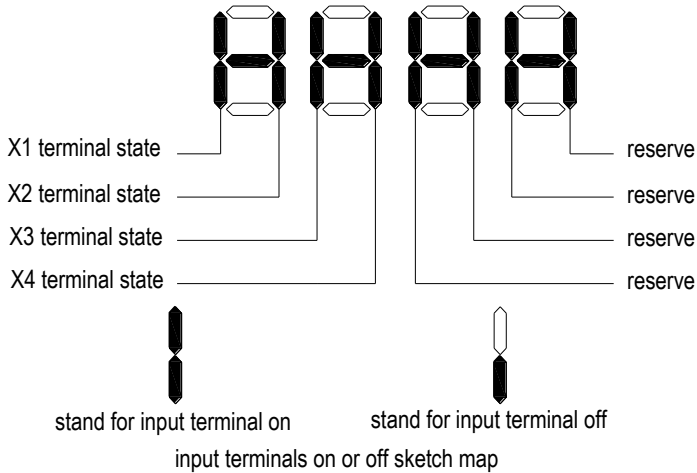

## Chapter 6 Operation Guidance

### 6.1 AM Motor Pump Drive Operation Guidance (Keyboard as an example)

#### 1) Wiring:

- Confirmed the solar pump drive if matching with motor.
- Correctly connect “+”“-” of solar panel to correspond “+”“-” pole of inverter or P1, N1 wiring terminals of AC/DC module. Pay attention to the polarity, otherwise it will cause inverter damage.
- While inputting AC power supply, connect “R” “S” “T” or “L” “N” of power grid to “R” “S” “T” or “R” “T” of AC/DC module.
- Connect motor wire and ground wire to corresponding U, V, W, E terminals.
- AC/DC module supports AC/DC switch function;

#### 2). Parameters setting and trial run:

- Set F0.00 to 1, F0.02 = 0, and F0.09, F0.11, F0.14, F0.15 parameters setting according to application site.
- Set motor(pump) parameters according to nameplate of pump
- Set solar pump MPPT mode FE.001 to 1 or 2
- Press FWD button for trial running, and confirm the motor running direction.

#### 3) Common problems

- Q : Well-lit conditions, the pump is running, but the water is very small.  
A : Check if the pump motor direction is reversed.
- Q : Well-lit conditions, the drive is in standby mode 0.00Hz  
A : Check FE.01, observe what protection status is the drive currently, and check whether the parameter set is reasonable;
- Q : DC current is incorrectly displayed.  
A : Adjust FE.30, FE.31 for calibration.
- Q : Well-lit conditions, frequency severe beating during operation  
A : Reasonably adjust FE.06 value, and the adjustment is recommended to be in the vicinity of the default, too big or too small will cause frequency oscillation;

### 6.2 Synchronous Motor Pump Drive Operation Guidance

#### 1) Wiring:

- Confirmed the solar pump drive if matching with motor.
- Correctly connect “+”“-” of solar panel to correspond “+”“-” pole of inverter or P1, N1 wiring terminals of AC/DC module. Pay attention to the polarity, otherwise it will cause inverter damage.
- While inputting AC power supply, connect “R” “S” “T” or “L” “N” of power grid to “R” “S” “T” or “R” “T” of AC/DC module.
- Connect motor wire and ground wire to corresponding U, V, W, E terminals.
- AC/DC module supports AC/DC switch function; (Specifications refer to the next version)

#### 2) Parameters setting and trial run:

- Set F0.00 to 6, F0.02 = 0, and F0.09=100.00, F0.11=100.00; F0.14, F0.15 can be set according to

demand.

b). Set motor (pump) parameters according to nameplate of pump. Then Set F5.12 =1, and the keypad will show T-00.Press FWD to start motor auto tuning. This process takes about three minutes;

Note: 1. If you can disconnect the motor and load, self-learning would be better;

2.The self-learning need to be done with enough sunshine and when the solar panels can provide enough energy.

c). Set solar pump MPPT mode FE.001 to 1 or 2

d). Press FWD button for trail running, and confirm the motor running direction.

### 3) Common problems and solutions

a, Q : Well-lit conditions, the pump is running, but the water is very small.

A : Check if the pump motor direction is reversed.

b, Q : Well-lit conditions, the drive is in standby mode 0.00Hz

A : Check FE.01, observe what protection status the drive is in currently, and check whether the protection parameters setting are reasonable;

c, Q : DC current is incorrectly displayed.

A : Adjust FE.30, FE.31 for calibration.

d, Q : Well-lit conditions, frequency severe beating during operation

A : Reasonably adjust FE.06 value, the adjustment is recommended to be in the vicinity of the default, too big or too small will cause frequency oscillation;

e, Q : The current fluctuation is huge when the pump is running.

A : Check C-39, adjusting the value of F5.24, so the C-39 displays the value from 0-10;

## 6.3 PV Water Pump Features

### A. Dormancy Function

During the photovoltaic pump operation, the inverter will go into dormancy state when the DC voltage provided by solar panels is lower than FE.11 (Dormancy voltage threshold) due to objective factors, and the keyboard displays warning "A.LPn"; when DC voltage provided by solar panels rises back to FE.12 (Dormancy recovery voltage) point, start timing and after FE.13 (Dormancy stop waiting time), the drive starts running;

### B. Low-frequency Protection Function

During the operation of the photovoltaic pump, for some reason, the output frequency is lower than FE.14 (low frequency detection frequency), and after FE.15 (low frequency detection time) time, enters into the standby protection state, while the keyboard warning "A.LF"; after entering into the standby protection state and after FE.16 (low frequency protection automatic recovery) time, automatically resume to running state;

### C. Dry Run Protection

During the operation of the photovoltaic pump, for some reason, the output current is less than FE.17 (dry protection current detection), and after FE.18 (dry run protection detection time) time, enters into standby protection state, while the keyboard warning "A.LuT"; after entering into the standby protection state and



after FE.19 (dry run protection automatic recovery) time, automatically resume to running state;

#### **D. Over-current Protection**

During the operation of the photovoltaic pump, for some reason, the output current is greater than FE.20(Over current protection detection current), and after FE.21 (Over current protection detection time) time, enters into standby protection state, while the keyboard warning "A.oLd "; after entering into the standby protection state and after FE.22 (over current protection automatic recovery)time, automatically resume to running state;

#### **E. Minimum Power Protection**

During the operation of the photovoltaic pump, for some reason, the output power is less than FE.23(minimum power protection value), and after FE.24 (minimum power protection detection time) time, enters into standby protection state, while the keyboard warning "A.LPr"; after entering into the standby protection state and after FE.25 (minimum power automatic recovery)time, automatically resume to running state;

#### **F. Fulfilled Water Protection**

Detect the water fulfilled alarm level and low water level through two X terminals to realize automatic level control. Wherein FE.27 is the water fulfill protection detection time and FE.28 is fulfilled water protection exit time, and X 3 terminal is defined as the input of solar water fulfilled detection alarm signal, and X4 terminal is defined as the input of solar water fulfilled detection alarm reset signal. The warning signal is shown as "A.Ful"

#### **G. Alarm Recovery Mode: 0: automatic recovery; 1: manual recovery**

This option is for low frequency protection, dry run protection, over-current protection, minimum power function; you can select the alarm restoration mode by FE.26. When you select 0 for automatic recovery, you can also press the "RESET" button for long to stop operation during fault warning displaying; when you select 1 for manual recovery, you can press the "RESET" button to manually clear, or press "RESET" button for long to achieve stop operation.

#### **H. PQ Curve Function**

This model provides a self-defined PQ curve for users to set up five groups of PQ corresponding points according to the pump cases, to achieve calculation of real-time flow speed, daily flow, cumulative flow, daily generated power and cumulative electricity consumption; of which by default, daily flow and generated power are calculated basing on 7h in a day.

#### **I. AC/DC Auto-switching Function**

The inverter can support multi-power auto-switching between solar DC power and AC power after optionally equipping AC/DC auto-switching module. When sunlight is very weak, it is able to switch to AC power automatically so that ensuring continuously working to achieve water-supply stability. When sunlight turns well, it switches back to solar DC power. This function affords to guarantee system working stably for 24 hours every day.

#### **J. Status Check**

When the solar pump is running, you can check FE.01 to confirm the current operating status.